

SAVE THESE INSTRUCTIONS

FRESNO SQ.

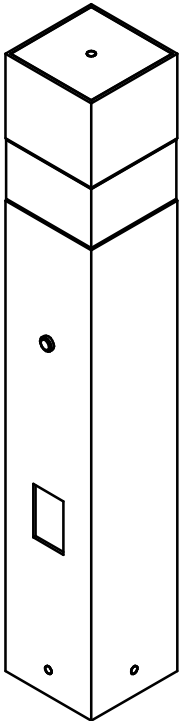

FRESNO RD.

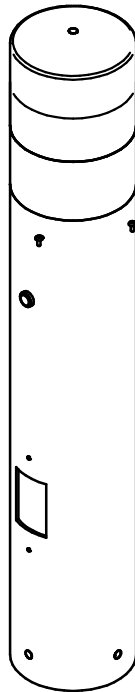

TEMPE SQ.

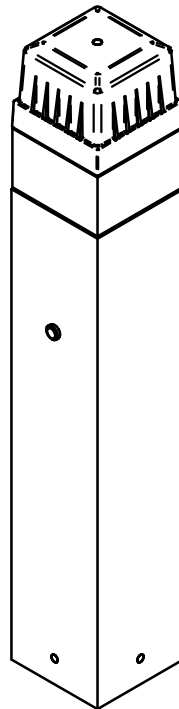

TEMPE RD.

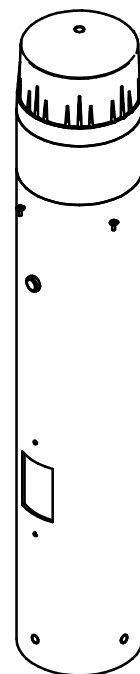

SAVE THESE INSTRUCTIONS
LED BOLLARD LIGHT FIXTURES
(FN1, FN2, TMS, TMR)

WARNING: DISCONNECT POWER BEFORE INSTALLATION OR SERVICING
READ INSTRUCTIONS CAREFULLY - FAILURE TO DO SO COULD RESULT IN
PERSONAL INJURY. RETAIN INSTRUCTIONS FOR SERVICING.

FIXTURE INSTALLATION

1. UNPACK LUMINAIRE AND CHECK FOR DAMAGE.
2. PLACE BASE OVER ANCHOR BOLTS.
SECURE BASE WITH WASHERS AND NUTS.
3. MAKE WIRING CONNECTIONS.
4. PLACE FIXTURE DOWN OVER BASE, LINING UP
THREADED HOLES IN BASE WITH COUNTERSUNK HOLES IN
FIXTURE HOUSING.

- LED LIGHT ARRAY CAN BE ADJUSTED BY LOOSENING
THREE MOUNTING SCREWS. (B)

- ONCE LED LIGHT ARRAY IS POINTING IN THE DISERED
DIRECTION TIGHTEN MOUNTING SCREWS

BEFORE ENERGIZING LED MAKE CERTAIN THAT:

- LINE VOLTAGE CORRESPONDS TO BALLAST
- LED LIGHT ARRAY IS POINTING IN DESIRED DIRECTION.

LED RELAMPING INSTRUCTIONS

1. REMOVE CAP BY LOOSENING ALLEN SOCKET SCREW
AND SEALING WASHER.
3. DISCONNECT LED LEADS FROM BALLAST
4. REPLACE LED BOARDS BY REMOVING TWO MOUNTING
SCREWS (C) FROM EACH BRACKET (D)
5. REVERSE ABOVE PROCEDURE TO RE-ASSEMBLE
FIXTURE BEING SURE SEALING WASHER IS ON SCREW,
NOTE: HEAD OF SCREW WILL NOT BE FLUSH WITH TOP OF
HOUSING DUE TO SEALING WASHER. DO NOT
OVERTIGHTEN TOP ALLEN HEAD SOCKET SCREW.

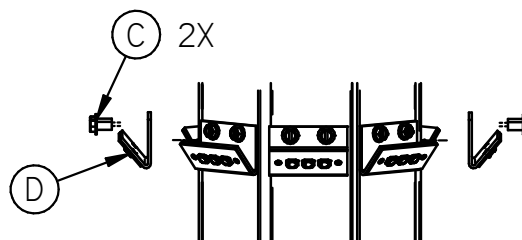
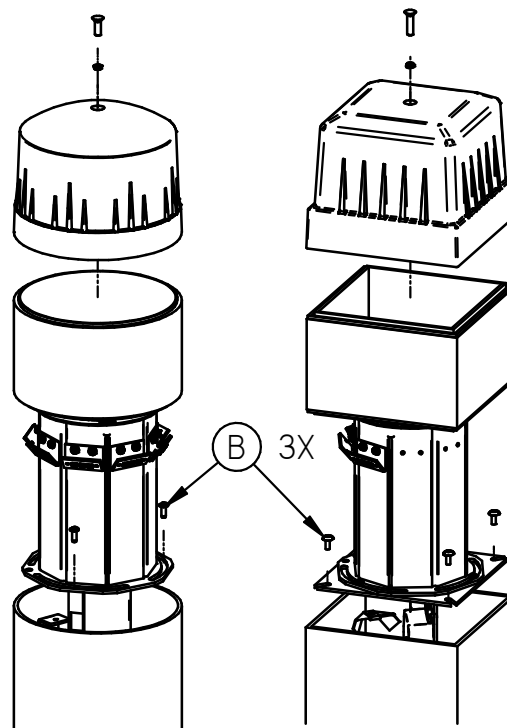
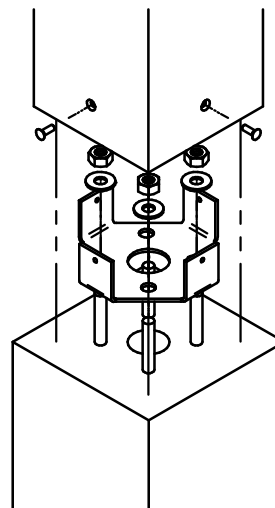

93036519_A
05/24/2011